

VT-121
VT-121F
VT-121S

AC VOLTMETER

INSTRUCTION MANUAL

CONTENTS

1	GENERAL
2	FEATURES
3	APPLICATIONS
4	UNIT DESCRIPTION
5	FUNCTIONAL CONTROLS
6	OPERATION
7	APPLICATIONS
8	MAINTENANCE
9	ALIGNMENT
10	CAUTIONS FOR USE
11	PARTS LIST
12	C. BOARD (K65-1210-00)
13	SCHEMATIC DIAGRAM

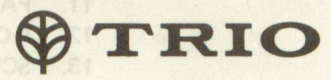

VT-151
VT-151F
VT-151S

AC VOLTMETER

CONTENTS

1. GENERAL	3
2. FEATURES	3
3. SPECIFICATIONS	4
4. CIRCUIT DESCRIPTION	5
5. FUNCTIONAL CONTROLS	9
6. OPERATION	10
7. APPLICATIONS	13
8. MAINTENANCE	15
9. ALIGNMENT	15
10. CAUTIONS FOR USE	17
11. PARTS LIST	18
12. P.C. BOARD (X65-1210-00)	26
13. SCHEMATIC DIAGRAM	27

1. GENERAL

Your TRIO'S Electronic Voltmeter, Model VT-121, is a voltmeter of absolute-mean value indication type capable of measuring AC voltages from $100 \mu\text{V}$ to 300V in the frequency range as wide as 5Hz to 1MHz on root-mean-square value scales. (The measurable voltage range of the F version is $150 \mu\text{V}$ to 500V .) Your VT-121 is available in a variety of applications as it is highly sensitive and responds accurately to given voltages in such a wide frequency range. For use on production lines, it can be controlled by a remote control device (option).

This manual is prepared in common to the three version of the Model VT-121, major differences of which are as follows.

VT-121: 1mV maximum sensitivity and BNC input and output connectors.

VT-121F: 1.5mV maximum sensitivity and BNC input and output connectors.

VT-121S: 1mV maximum sensitivity and dual input and output connectors.

2. FEATURES

- a. All solid-state circuit provides a highly stable operation, reduces warm-up time and saving power.
- b. Dual power differential input amplifiers used in the entire circuit provide a high reliability and good characteristic of restoration from possible saturation due to excessive inputs.
- c. A large-sized Taut-band meter has a high sensitivity and reliability.
- d. The number of adjusting trimmers are minimized with the use of the amplifiers which are precisely calculated in the open loop gains and are negative-biased through metal-film resistors as accurate as 1%. The amplifier characteristics, therefore, are free from any secular change.
- e. The input resistance is as high as $10 \text{M}\Omega$ in all ranges and its parallel capacitance is 45pF or lower.
- f. The meter scales are graduated in the root-mean-square values for sinusoidal waves. Also, the meter has a dB and dBm scales convenient for measuring relative values.
- g. The output terminal allows your VT-121 to use as a high-gain, wide-band amplifier.
- h. The input attenuators are switched by a so-called "logic control circuit" so that a desired range can be selected with use of a remote control device (option).
- i. A relay and FET switch for range selection, controlled by the logic control circuit, provide higher reliability than usual rotary switch direct switching.

3. SPECIFICATIONS

Values brackets [] are for the F version

[Meter Section]

Measurable voltages:	1mV–300V in 12 ranges: 1mV, 3mV, 10mV, 30mV, 100mV, 300mV, 1V, 3V, 10V, 30V, 100V, and 300V full scales. [1.5mV–500V in 12 ranges: 1.5mV, 5mV, 15mV, 50mV, 150mV, 500mV, 1.5V, 5V, 15V, 50V, 150V, and 500V full scales.]
dB:	–80 ~ +50dB (0dB = 1V).
dBm:	–80 ~ +52dBm [–80 ~ +56dBm] (0dBm = 1mV, 600 Ω).
Error:	Within $\pm 3\%$ of full scale at 1kHz.
Frequency response:	$\pm 10\%$ at 5Hz – 1MHz, $\pm 5\%$ at 10Hz – 500kHz and $\pm 2\%$ at 20Hz – 100kHz as referenced to 1kHz response.
Input impedance:	10M $\Omega \pm 5\%$, with less than 45pF parallel capacitance.
Durable input voltage:	500V [770V] DC + AC peak. 100V DC + AC peak up to –10dB.
Stability:	Within $\pm 0.5\%$ of full scale for $\pm 10\%$ line voltage fluctuation.
Temperature coefficient:	$\pm 0.08\%/^{\circ}\text{C}$.

Operating

temperature:	0 – 50 $^{\circ}\text{C}$.
Relative humidity:	80%.
[Amplifier Section]	
Gain:	60 dB ± 1 dB [51 dB ± 1 dB].
Output voltage:	1Vrms $\pm 10\%$.
Output resistance:	600 $\Omega \pm 10\%$.
Distortion:	Less than 1% at full scale. (Rated by signal-noise ratio in 1mV and 1V [1.5mV and 1.5V] ranges.)
Signal-to-noise ratio:	Over 40dB at full scale.
Frequency response:	Within ± 3 dB at 5Hz – 500kHz.
[Power Supply Section]	
Line voltage:	100, 120, 220, or 240V AC $\pm 10\%$, 50/60Hz.
Power consumption:	Below 5W.
Dimensions:	128(130)W x 190(215)H x 238(260)Dmm. Values in () include protrusions.
Net weight:	2.9 kg.
[Accessories]	
Power cable:	JIS cable, 1 pc.
Input cable:	CA-41, 1 pc.
Replacement fuse:	0.1A 2 pcs. 0.2A 2 pcs.
Instruction manual:	1 copy.

4. CIRCUIT DESCRIPTION

In studying the operation of each circuit in your Model VT-121, please refer to Figure 1, the "Block Diagram", and the Schematic Diagram on the back cover.

• Outline of Operation

A signal voltage to be measured, which is input from the INPUT connector, is passed through the First Attenuator and is converted to a low impedance by the Impedance Converter. The impedance-converted signal is further attenuated through the Second and Third Attenuators and is magnified by the Main Amplifier. The magnified signal is fed to the Output Amplifier and the Relative Reference Control.

The Output Amplifier magnifies the signal 50-fold and feeds to the OUTPUT connector. The Relative Reference Control sets the signal level for relative reference. The Absolute-Mean Value Detector converts the referenced signal to DC current in proportion to the absolute mean value. The converted signal activates the Meter. The Attenuator Control encodes the signal led from the RANGE selector to generate an attenuator control signal. This signal controls the First, Second, and Third Attenuators. The Power Supply feeds to the functional circuits ± 5 V DC voltages stabilized by its IC regulator.

• Description of Functional Circuits

1. First Attenuator

A resistance divider attenuator. The amount of attenuation is switched in two steps by relay contacts:

0 dB and -60 dB.

2. Impedance Converter

A voltage follower circuit having a FET differential input. This converts the First Attenuator output signal to a sufficiently low impedance and feeds to the Second Attenuator.

3. Second Attenuator

A resistance divider attenuator. The amount of attenuation is switched in two steps by relay contacts: 0 dB and -30 dB.

4. Third Attenuator

A resistance divider attenuator. The amount of attenuation is switched in four steps by a FET switch: 0 dB, -10 dB, -20 dB, and -30 dB.

5. Main Amplifier

A wide-band, non-phase-inversion amplifier having a differential input. This has high input impedance, low output impedance, and 20-fold gain. The output signal level is 20 mVrms for the full-scale read on the Meter.

6. Output Amplifier

A wide-band non-phase-inversion amplifier with a differential input. This works stably even for capacitive loads. The gain is 50-fold and the output impedance 600Ω . The output signal level is 1 Vrms for the full-scale read on the Meter.

7. Absolute-Mean Value Detector

An absolute-mean value detector comprised of a high

through-rate, high gain amplifier with a differential input. This has a very good linearity as negative-biased by the voltage detected from the current flowing through the Meter load. In switching, this provides a sufficiently wide frequency band so that the high-frequency phase correction circuit is reset.

8. Attenuator Control

A logic control circuit comprised of a diode matrix and output buffer transistors. This encodes a 12-bit signal from the RANGE selector switch to 6-bit signals, which control the First, Second, and Third Attenuators. The remote control connector is connected to this circuit.

9. RANGE Selector

A 12-contact rotary switch for selecting a desired measurable voltage range. This feeds a signal corresponding to the range into the Attenuator Control.

10. RELATIVE REF Control

A control for setting a reference voltage in measuring a relative value with use of the dB scales and the like. This is capable of varying up to 10 dB.

11. Power Supply

A power source of converting the AC 10V input to $\pm 5V$ DC outputs to supply. This has a silicon diode bridge for full-wave rectification, high-capacitance electrolytic capacitors for smoothing, and an IC regulator for stabilization.

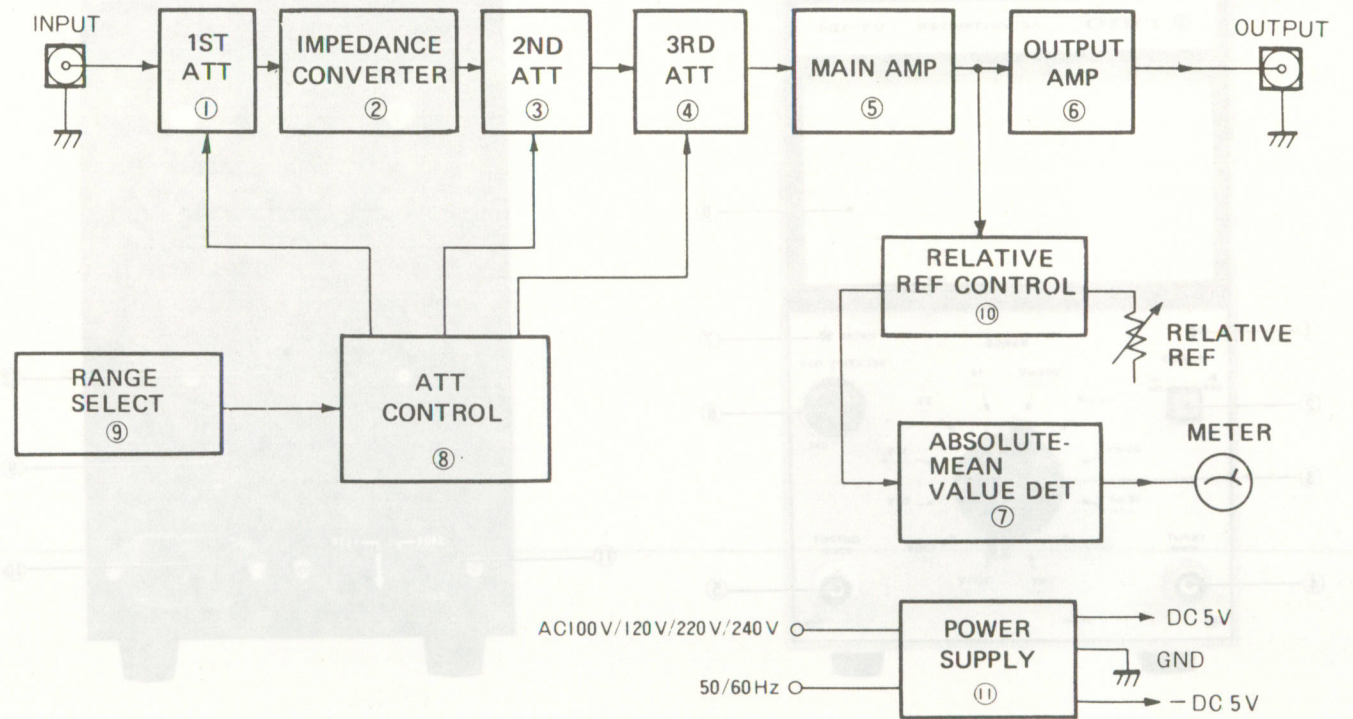

Figure 1 – Block Diagram.

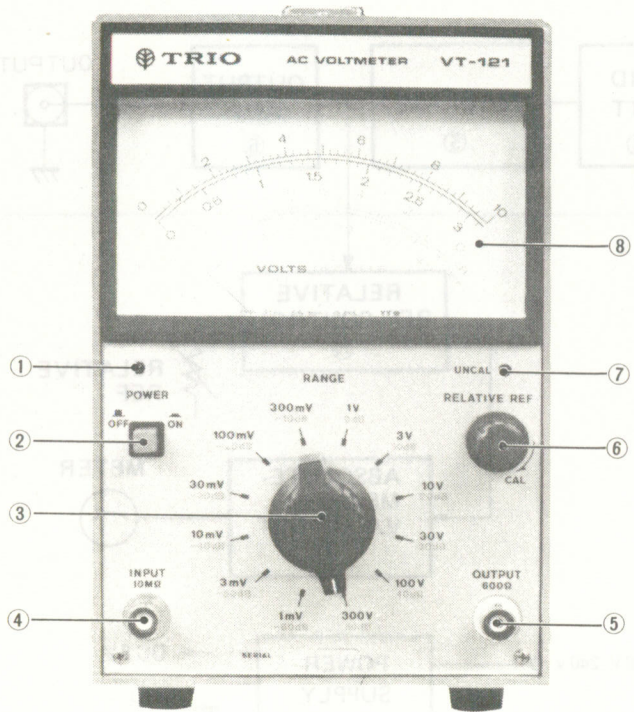

Figure 2 – Front Panel View.

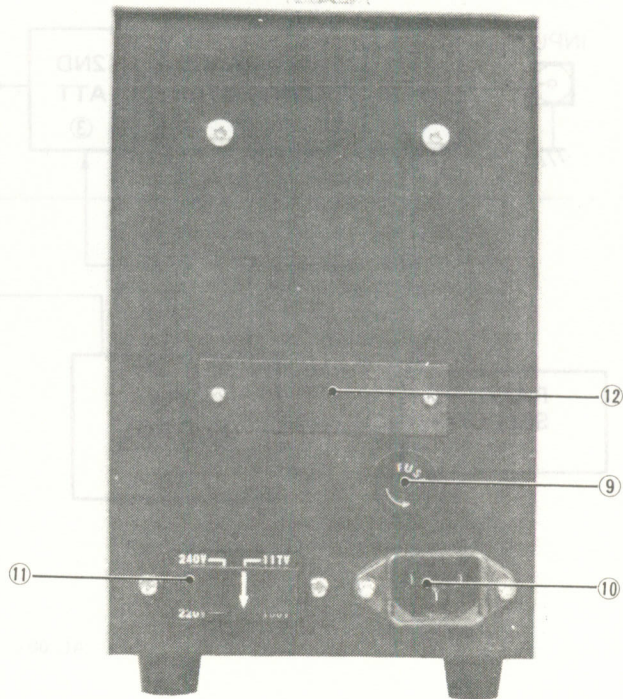

Figure 3 – Rear Panel View.

5. FUNCTIONAL CONTROLS

1) Front Panel (see Figure 2)

1. Power-on indicator
2. POWER: Power ON-OFF switch
3. RANGE: Measurable voltage range selector switch
4. INPUT, 10M Ω : Input connector, 10M Ω impedance
5. OUTPUT, 600 Ω : Output connector, 600 Ω impedance
6. RELATIVE REF: Relative reference control
7. UNCAL: Uncalibration indicator
8. Meter

2) Rear Panel (see Figure 3)

9. FUSE: Fuse holder
10. Power connector
11. Line voltage selector
12. Remote control connector (option) blind.

3) Preset Controls on Side Panel (see Figure 4)

The following controls, placed on the Main PC board (X65-1210-00), are to be preset on the right-hand side panel.

13. TC101: First Attenuator preset trimmer capacitor
14. VR101: First Attenuator preset variable resistor
15. VR102: Meter Amplifier gain preset variable resistor

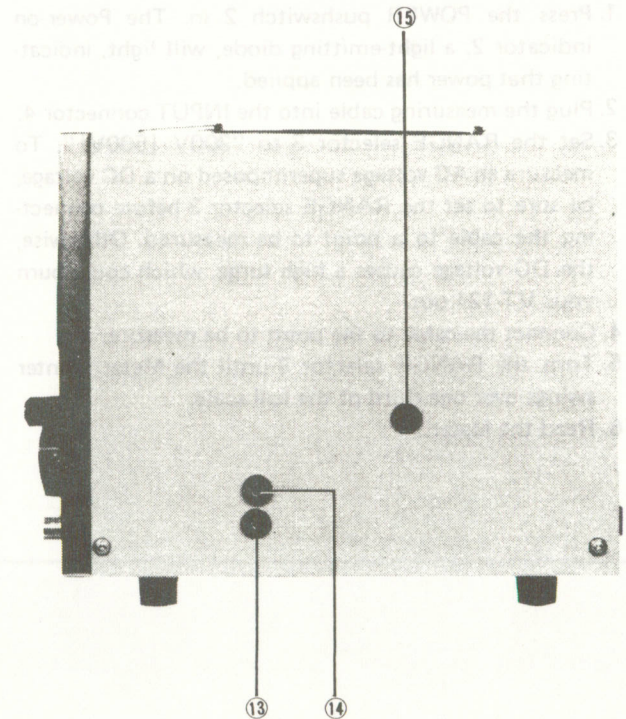

Figure 4 — Preset Controls on Side Panel.

6. OPERATION

• Set-up

Values in brackets [] are in the F version.

1. Press the POWER pushswitch 2 in. The Power-on indicator 2, a light-emitting diode, will light, indicating that power has been applied.
2. Plug the measuring cable into the INPUT connector 4.
3. Set the RANGE selector 3 to "300V [500V]". To measure an AC voltage superimposed on a DC voltage, be sure to set the RANGE selector 3 before connecting the cable to a point to be measured. Otherwise, the DC voltage causes a high surge, which could burn your VT-121 out.
4. Connect the cable to the point to be measure.
5. Turn the RANGE selector 3 until the Meter pointer swings over one third of the full scale.
6. Read the Meter.

FUNCTIONAL CONTROLS

VT-121, VT-121S

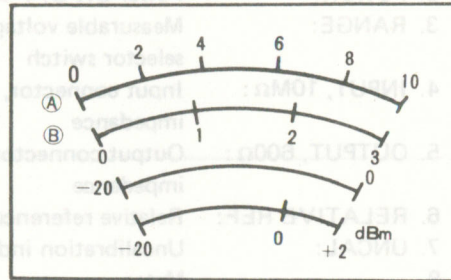

VT-121F

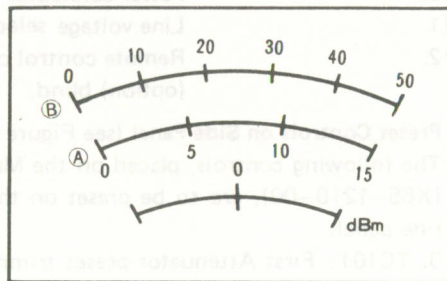

Figure 5 – Meter Scale Graduations.

(1) Voltage Scales

There are two black voltage scales: a scale A graduated 0 to 10 [0 to 15] and a scale B 0 to 3 [0 to 50]. When the RANGE selector 3 is at "1V [1.5V]", for example, the division 10 on the scale A indicates 1V [the division 15 is 1.5V]. At the "300mV [500mV]" position, the division 3 on the scale B indicates 300 mV [the division 50 is 500 mV]. Similarly, the other RANGE selector positions show their full scale values.

(2) dB Scale

In general, the dB values are expressed in dBV which is a unit referenced by 0 dB equal to 1 V. (Note that the F version has no dB scale.) The division 10 at the scale A corresponds to 0 dB on the red dB scale, which is a voltage ratio scale. Since the RANGE selector has 12 range positions in steps of 10 dB, the voltage ratio of 1 mV to 300 V is 110 dB attenuation. Assume a reference voltage level on the scale A be 1 V with the RANGE selector at "1V", a given voltage can be read as low as -60 dB (1 mV) by turning the selector downward. Further, as the scale A allows reading to -20 dB (0.1 mV), you can continuously measure the voltage ratio as high as -80 dB (0.1 mV to 1 V). The read of -80 dB means a signal-to-noise ratio of around 20 dB. Also, the dB scale allows continuous measuring up to +50 dB (1 to 300 V) by turning the selector upward.

(3) dBm Scale

In general, voltmeters have a reference level division of 0 dBm equal to 0.775 V (1 mV power) induced across a 600 Ω resistance load. Therefore, the red dBm scale is available to measure a power level referenced to 0 dBm, with the impedance of the given power circuit being 600 Ω pure resistance. Where measured across specific resistance loads, for example, 10k Ω , other than the 600 Ω load, the levels are sometimes expressed in dBs.

• How to Use Remote Control

Availability of the optional Remote Control is one of outstanding features of your VT-121. To attach the Remote Control, remove the blind plate at the rear of your VT-121. Install and plug the optional connector into the 16-pin connector on the PC board. Wire it to the multi-pin connector (plug) supplied with the option. Also, wire its pins to a RANGE pushswitch or rotary switch and to a PANEL-REMOTE switch (toggle switch, pushswitch or slide switch). These switches allows you to change the measuring voltage range on your VT-121 from a distance place.

• How to Use Relative Reference Control

The RELATIVE REF control is kept at "CAL" in general cases of reading calibrated, absolute values on

the Meter. To measure relative levels such as frequency responses, turn the control for uncalibration state (UNCAL) until the reference level is set to a desired value, for example, 0 dBm. This allows reading the relative levels.

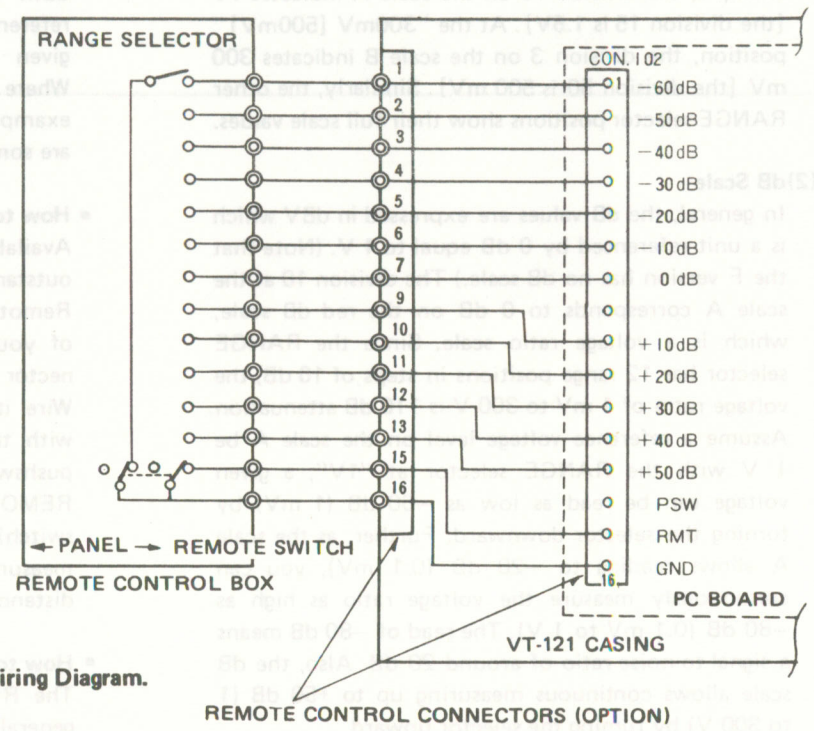

Figure 6 – Remote Control (Option) Wiring Diagram.

7. APPLICATIONS

The basic use of your VT-121 is to measure sinusoidal wave voltages as an AC voltmeter. In addition, it provides a wide variety of applications as described below.

(1) Amplifier Gain Measurement

Your VT-121 is capable of measuring an amplifier gain, which is a signal magnification from point A to B in Figure 7 with a signal generator connected to the amplifier input. If the measured signal levels at points A and B are a and b dB, respectively, then the gain is $(b - a)$ dB.

Also, the method is applicable to negative-feedback amplifiers; that is, it is available for measuring an open loop gain of each amplifier circuit with the negative-feedback signal leaves applied.

Further, the method can be used for measuring the frequency responses of given circuits by changing the signal generator frequency.

As an example, let us calculate the open loop gain (from point A to B) of the negative-feedback amplifier shown in Figure 8. Assume that the measured level at point A be +1.5 dB in the -60 dB range and that of point B -4 dB in the +10 dB range. The gain from point A to B is

$$(+10\text{dB} - 4\text{dB}) - (-60\text{dB} + 1.5\text{dB}) = 64.5\text{dB}.$$

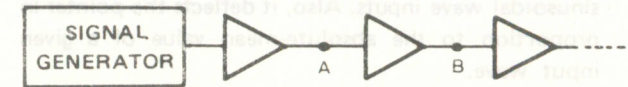

Figure 7 – Amplifier Gain Measurement.

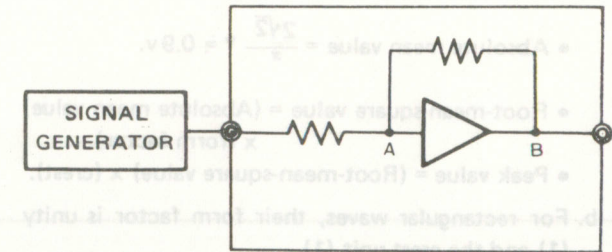

Figure 8 – Negative Feedback Amplifier Gain Measurement.

(2) Root-Mean-Square and Peak Value Calculations

Your VT-121, an voltmeter of absolute-mean value indication type, reads root-mean-square values of sinusoidal wave inputs. Also, it deflects the pointer in proportion to the absolute-mean value of a given input wave.

If the form factor (= root-mean-square value/absolute mean value) of the input wave and the crest (= peak value/root-mean-square value) are known, then the root-mean-square value and peak value can be calculated as follows.

a. Assume that the meter reads v .

- Absolute mean value = $\frac{2\sqrt{2}}{\pi} v \doteq 0.9 v$.

- Root-mean-square value = (Absolute mean value) x (form factor).

- Peak value = (Root-mean-square value) x (crest).

b. For rectangular waves, their form factor is unity (1) and the crest unit (1).

- Absolute mean value = $\frac{2\sqrt{2}}{\pi} v \doteq 0.9 v$.

- Peak value = $0.9 v$.

c. For sawtooth waves, their form factor is $2/\sqrt{3}$ and the crest $\sqrt{3}$.

- Absolute mean value = $\frac{2\sqrt{2}}{\pi} v \doteq 0.9 v$.

• Root-mean-square value =

$$\frac{2\sqrt{2}}{\pi} \times \frac{2}{\sqrt{3}} v = \frac{4\sqrt{2}}{\pi\sqrt{3}} v \doteq 1.04 v.$$

- Peak value = $\frac{4\sqrt{2}}{\pi\sqrt{3}} \times \sqrt{3} v = \frac{4\sqrt{2}}{\pi} v \doteq 1.8 v$.

8. MAINTENANCE

(1) Removing the casing (see Figure 9)

1. Remove the six screws holding the casing on the both sides and top using a Phillips screw driver.
2. Widen the bottom of the 7-shaped casing a little and pull it up for removal.

(2) Mounting the casing (see Figure 10)

1. Widen the bottom of the casing a little when covering it over the main body.
2. Fit the casing PC board retainer to the PC board retainer
3. Alternately tighten the six screws for uniform torque.

CAUTION: Excessive tightening could cause damaging the screw or breaking the vinyl leather. Be careful!

(3) Replacing the fuse

1. Open the fuse holder using a Phillips screw driver.
2. Replace the fuse.

CAUTION: Be sure to select the fuse of rated capacity. For a 100 and 120 V AC lines, use a 0.2 A fuse; for a 220 and 240 V AC lines, a 0.1 A fuse.

9. ALIGNMENT

Values in brackets [] are in the F version; Your VT-121 was precisely preset at the factory. However, it can be aligned through the adjust holes located on the right-hand side with leaving it housed in the casing, if required. In realignment, first adjust the line voltage to the voltage, use a precisely calibrated measuring instruments, and proceed as follows (also, see Figures 2 through 4).

1. Before turning the POWER switch "ON", adjust the Meter zero-adjust screw until the pointer correctly indicates "0".
2. Connect a voltmeter calibrator 1 kHz (or 400 Hz) output to the INPUT connector 4.
3. Set the voltmeter calibrator output voltage to 30 mV [50 mV] and set the RANGE selector 3 on your VT-121 to the "30 mV [50 mV]" range.
4. Adjust VR102 until the pointer swings to the full scale.
5. In turn, set the voltmeter calibrator output voltage to 10 V [15 V] and set the RANGE selector 3 to the "10V [15V]" range.
6. Adjust VR101 until the pointer swings to the full scale.
7. Disconnect the voltmeter calibrator and connect a wide-band signal generator to the INPUT connector 4.
8. Set the signal generator frequency to 1 kHz and set the RANGE selector 3 on your VT-121 to the "1V" range.

9. Adjust the signal generator output voltage until the pointer swings to the full scale.
10. Change the signal generator frequency from 1 kHz to 50 kHz.
11. Adjust TC101 until the pointer swings to the full scale.
12. Repeat Steps 2 through 11.

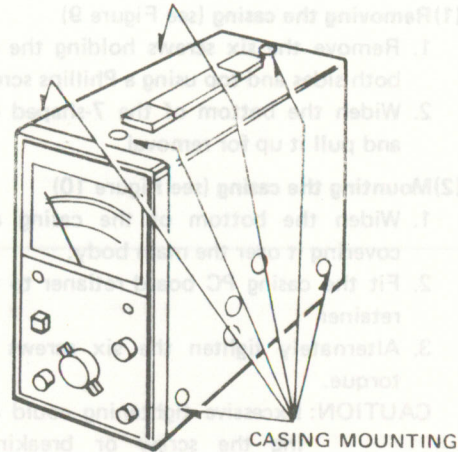

Figure 9 – Casing Removal.

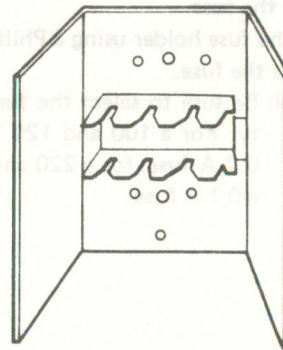

Figure 10 – PC Board Retainer.

10. CAUTIONS FOR USE

1. Your VT-121 will work just when the POWER switch is pressed in. For accurate measurements, wait around five minutes for warm-up.
2. Avoid placing your VT-121 where magnetic field and electric field are too strong.
3. The input cable other than the supplied one should be low-capacitance shielded cord, or coaxial cable.
4. The continuous maximum input voltage allowable for your VT-121 is 80 Vrms with the RANGE selector at “-60dB” to “-10dB”. Full care should be observed in measuring high voltages.
5. Be careful of a line noise and similar small noises as your VT-121 is a highly sensitive voltmeter.
6. Do not leave your VT-121 at any of high temperature and humidity places for a long period of time.
7. The VT-121S version, unlike the other two, is equipped with input terminals in place of the connector. Be careful of the terminals as these could induce external hum and noises.

CIRCUIT NO.	PARTS NO.	DESCRIPTION
	F01-0012-05	Fuse 0.2A
	E31-0023-05	Lead wire with connector
	E31-0022-05	Lead wire with connector
	E30-1818-05	JIS cord
	E33-0015-04	Grounding lug
	E33-0513-05	Grounding lug
	E31-0509-13	Pair terminal
	E08-0681-05	Voltage selector, plug
	E08-1081-05	Voltage selector, receptacle
	E04-0583-05	Receptacle type BNC
	E04-0581-05	Receptacle type BNC
	E03-0501-05	Power connector
	B80-2843-00	Instruction manual
	B41-0705-04	Name plate (lower part)
	B40-5352-04	Name plate (VT-121S)
	B40-5354-04	Name plate (VT-121E)
	B40-5353-04	Name plate (VT-121)
	B40-0785-14	Name plate
	B31-0108-05	Meter
	R07-0180-04	Electrometer
	A51-0813-04	Panel
	A51-0821-05	Component panel
	A51-0820-05	Component panel
	A50-5312-03	Panel
	A16-0417-13	Control
	A01-0818-15	Case

11. PARTS LIST of VT-121

10. CAUTIONS FOR USE

1. Your VT-121 will work just when the POWER switch is pressed in. For accurate measurement, wait

CIRCUIT NO.	PARTS NO.	DESCRIPTION	REMARKS
	A01-0818-12	Case	
	A10-1417-12	Chassis	
	A20-2715-32	Panel	
	A21-0820-08	Ornamental panel	F version
	A21-0821-08	Ornamental panel	S version
	A21-0819-04	Panel	
	B07-0190-04	Escutcheon	
	B31-0708-05	Meter	
	B31-0709-05	Meter	F version
	B40-0765-14	Name plate	
	B40-2723-04	Name plate (VT-121)	
	B40-2724-04	Name plate (VT-121F)	
	B40-2725-04	Name plate (VT-121S)	
	B41-0702-04	Name plate (power source)	
	B50-2842-00	Instruction manual	
	E03-0201-05	Power connector	
	E04-0251-05	Receptacle, type BNC	
	E04-0253-05	Receptacle, type BNC	
	E08-1081-05	Voltage selector, receptacle	
	E09-0681-05	Voltage selector, plug	
	E21-0209-13	Pair terminal	S version
	E23-0513-05	Grounding lug	
	E23-0015-04	Grounding lug	S version
	E30-1818-05	JIS cord	
	E31-0535-05	Lead wire with connector	
	E31-0533-05	Lead wire with connector	
	F05-2012-05	Fuse 0.2A	

CIRCUIT NO.	PARTS NO.	DESCRIPTION	PARTS NO.	REMARKS
	F05-1012-05	Fuse 0.1A		
	F11-0914-04	Shield case		
	F15-0703-04	Blind plate		
	F19-0703-04	Patch		
	H01-2826-04	Packing case		
	H10-2802-02	Packing material, foamed styrene		
	H20-1703-04	Protection cover		
	H25-0029-04	Polyethylene bag		
	J03-0003-04	Rubber leg		
	J10-0038-03	Bezel		
	J10-0042-03	Bezel assembly		
	J10-0043-03	Bezel assembly		
	J10-0044-03	Bezel assembly		
	J13-0033-15	Fuse holder		
	J21-2840-04	P.C. Board retainer		
	J21-2842-04	Diode mounting hardware		
	J21-2843-04	Meter mounting hardware		
	J21-2844-04	Switch mounting hardware		
	J42-0038-04	Hole bush		
	J61-0049-05	Cable wrapping band		
	K01-0058-25	Grip		
	K21-0812-04	Knob 30φ		
	K21-0306-04	Knob 17φ		
	K21-0807-04	Knob		
	L01-9086-05	Power transformer		
	R01-1501-05	Variable resistor with switch		
				F version S version

CIRCUIT NO.	PARTS NO.	DESCRIPTION	DESCRIPTION	PARTS NO.	REMARKS
	S01-1505-05 S40-2506-05	Rotary switch Push switch		F08-1012-00 F11-0014-04 F12-0003-04 F19-0004-04	
		Light-emitting diode			
	X65-1210-00 X65-1210-01	Main unit Main unit		H01-2828-04 H10-2802-03 H20-1003-04	F version
	E30-1824-05 X67-1000-00	Input cable CA-41 Input cable CA-36		H25-0020-04 J09-0003-04 J10-0008-03 J10-0043-03 J10-0043-03 J10-0044-03 J13-0003-12 J21-2840-04 J21-2842-04 J21-2843-04 J21-2844-04 J21-2844-04 J22-0008-04 J21-0000-00 K07-0002-20 K21-0013-04 K21-0004-04 K21-0007-04 L01-0004-00 L01-0004-00	S version
F version S version					

PARTS LIST of X65-1210-00

CIRCUIT NO.	PARTS NO.	DESCRIPTION	REMARKS
RESISTOR			
R101	R92-0744-05	Metal film 9.99 M Ω \pm 0.5% 1/2W	
R102	RN14AK2E9531F	Metal film 9.5 k Ω \pm 1% 1/4W	
R103	RS14AB3A682J	Carbon 6.8 k Ω \pm 5% 1W	
R104	RD14BB2E681J	Carbon 680 Ω \pm 5% 1/4W	
R105	RD14BB2E222J	Carbon 2.2 k Ω \pm 5% 1/4W	
R106	RD14BB2E335J	Carbon 3.3 M Ω \pm 5% 1/4W	
R107	RD14BB2E472J	Carbon 4.7 k Ω \pm 5% 1/4W	
R108	RD14BB2E201J	Carbon 200 Ω \pm 5% 1/4W	
R109	RD14BB2E102J	Carbon 1 k Ω \pm 5% 1/4W	
R110	RD14BB2E750J	Carbon 75 Ω \pm 5% 1/4W	
R111	RN14BK2E1100D	Metal film 110 Ω \pm 0.5% 1/4W	
R112	R92-0786-05	Metal film 1.56 k Ω \pm 0.5% 1/4W	
R113	R92-0787-05	Metal film 60 Ω \pm 0.5% 1/4W	
R114, 115	RN14B.K2E2780D	Metal film 278 Ω \pm 0.5% 1/4W	
R116	RN14B.K2E1900D	Metal film 190 Ω \pm 0.5% 1/4W	
R117	RD14BB2E151J	Carbon 150 Ω \pm 5% 1/4W	
R118 ~ 120	RN14BK2E4110D	Metal film 411 Ω \pm 0.5% 1/4W	
R121	RD14BB2E150J	Carbon 15 Ω \pm 5% 1/4W	
R122 ~ 125	RD14BB2E472J	Carbon 4.7 k Ω \pm 5% 1/4W	
R126 ~ 137	RD14BB2E114J	Carbon 110 k Ω \pm 5% 1/4W	
R138	RD14BB2E334J	Carbon 330 k Ω \pm 5% 1/4W	
R139	RD14BB2E683J	Carbon 68 k Ω \pm 5% 1/4W	
R140	RD14BB2E432J	Carbon 4.3 k Ω \pm 5% 1/4W	
R141	RD14BB2E121J	Carbon 120 Ω \pm 5% 1/4W	
R142	RD14BB2E432J	Carbon 4.3 k Ω \pm 5% 1/4W	
R143	RD14BB2E272J	Carbon 2.7 k Ω \pm 5% 1/4W	

CIRCUIT NO.	PARTS NO.	DESCRIPTION			REMARKS	
R144	RN14BK2E6191F	Metal film	6.19 k Ω	$\pm 1\%$	1/4W	(F version)
(R144)	(RN14BK2E3741F)	(Metal film)	(3.74 k Ω)	($\pm 1\%$)	(1/4W)	
R145	RD14BB2E681J	Carbon	680 Ω	$\pm 5\%$	1/4W	
R146	RN14BK2E3010F	Metal film	301 Ω	$\pm 1\%$	1/4W	
R147	RD14BB2E121J	Carbon	120 Ω	$\pm 5\%$	1/4W	
R148	RD14BB2E3R3J	Carbon	3.3 Ω	$\pm 5\%$	1/4W	
R149	RD14BB2E432J	Carbon	4.3 k Ω	$\pm 5\%$	1/4W	
R150	RD14BB2E390J	Carbon	39 Ω	$\pm 5\%$	1/4W	
R151	RD14BB2E432J	Carbon	4.3 k Ω	$\pm 5\%$	1/4W	
R152, 154	RD14BB2E220J	Carbon	22 Ω	$\pm 5\%$	1/4W	
R155	RD14BB2E272J	Carbon	2.7 k Ω	$\pm 5\%$	1/4W	
R156	RD14BB2E3R3J	Carbon	3.3 Ω	$\pm 5\%$	1/4W	
R157	RD14BB2E681J	Carbon	680 Ω	$\pm 5\%$	1/4W	
R158	RN14BK2E1692F	Metal film	16.9 k Ω	$\pm 1\%$	1/4W	
R159	RN14BK2E3010F	Metal film	301 Ω	$\pm 1\%$	1/4W	
R160	RD14BB2E681J	Carbon	680 Ω	$\pm 5\%$	1/4W	
R161	RN14BK2E5230F	Metal film	523 Ω	$\pm 1\%$	1/4W	
R162	RD14BB2E152J	Carbon	1.5 k Ω	$\pm 5\%$	1/4W	
R163	RN14BK2E3010F	Metal film	301 Ω	$\pm 1\%$	1/4W	
R164	RN14BK2E3480F	Metal film	348 Ω	$\pm 1\%$	1/4W	
R165, 166	RD14BB2E432J	Carbon	4.3 k Ω	$\pm 5\%$	1/4W	
R167	RD14BB2E390J	Carbon	39 Ω	$\pm 5\%$	1/4W	
R168	RD14BB2E681J	Carbon	680 Ω	$\pm 5\%$	1/4W	
R169	RD14BB2E114J	Carbon	110 k Ω	$\pm 5\%$	1/4W	
R170	RD14BB2E683J	Carbon	68 k Ω	$\pm 5\%$	1/4W	
R171, 172	RD14BB2E331J	Carbon	330 Ω	$\pm 5\%$	1/4W	
R173	RN14BK2E10R0F	Metal film	10 Ω	$\pm 1\%$	1/4W	
R174	RD14BB2E331J	Carbon	330 Ω	$\pm 5\%$	1/4W	
R177, 178	RD14BB2E472J	Carbon	4.7 k Ω	$\pm 5\%$	1/4W	
R179	RD14BB2E331J	Carbon	330 Ω	$\pm 5\%$	1/4W	
R180	RD14BB2E472J	Carbon	4.7 k Ω	$\pm 5\%$	1/4W	
R181	RD14BB2E201J	Carbon	200 Ω	$\pm 5\%$	1/4W	

CIRCUIT NO.	PARTS NO.	DESCRIPTION	DESCRIPTION	REMARKS
VR101	R12-1002-05	Semi-fixed resistor	1 kΩB	
VR102	R12-0056-05	Semi-fixed resistor	100 ΩB	
CAPACITOR				
C101	C91-0545-05	Mylar	0.047μF ±20% 630WV	
C102	CQ93M1H472J	Mylar	4700pF ± 5% 50 WV	
C103	CQ93M1H222M	Mylar	0.0022μF ± 20% 50 WV	
C104	CQ93M1H222J	Mylar	0.0022μF ± 5% 50 WV	
C105,106	CE04W0J331	Electrolytic	330μF 6.3 WV	
C107	CC45SL1H470J	Ceramic	47pF ± 5% 50 WV	
C108	CE04W0J331	Electrolytic	330μF 6.3 WV	
C110	CE04W0J100	Electrolytic	10μF 6.3 WV	
C111	CC45SL1H010C	Ceramic	1pF ±0.25pF 50 WV	
(C111)	(CC45SL1H020C)	(Ceramic	2pF ±0.25pF 50 WV)	(F version)
C112	CC45SL1H020C	Ceramic	2pF ±0.25pF 50 WV	
C113 ~ 115	CE04W0J331	Electrolytic	330μF 6.3 WV	
C116, 117	CC45SL1H120J	Ceramic	12pF ± 5% 50 WV	
C118	CE04W0J331	Electrolytic	330μF 6.3 WV	
C119	CE04W0J470	Electrolytic	47μF 6.3 WV	
C120				
C121	CE04W0J470	Electrolytic	47μF 6.3 WV	
C122	CE04W0J471	Electrolytic	470μF 6.3 WV	
C123	CE04W0J470	Electrolytic	47μF 6.3 WV	
C124	CC45CH1H220J	Ceramic	22pF ± 5% 50 WV	
C126	CE04W0J331	Electrolytic	330μF 6.3 WV	
C128	CC45SL1H030C	Ceramic	3pF ±0.25pF 50 WV	
C129, 130	CE04BW1H010M	Non-polarized electrolytic	1μF ± 20% 50 WV	
C132, 133	CE04W0J470	Electrolytic	47μF 6.3 WV	
C134, 135	CE02W1C102	Electrolytic	1000μF 16 WV	
C136 ~ 139	CK45F1H104Z	Ceramic	0.1μF +80% - 20% 50 WV	
C140	CQ93M1H222M	Mylar	0.0022μF ± 20% 50 WV	

CIRCUIT NO.	PARTS NO.	DESCRIPTION	DESCRIPTION	REMARKS
C141	CK45F1H104Z	Ceramic	0.1 μ F +80% - 20% 50WV	
C142	CC45SL1H120J	Ceramic	12pF \pm 5% 50 WV	
C143, 144	CC45SL2H020C	Ceramic	2pF \pm 0.25pF	
C147	CK45D1H103M	Ceramic	0.01 μ F \pm 20%	
C148	CC45CH1H100D	Ceramic	10pF \pm 0.05pF	
TC101	C05-0402-05	Ceramic trimmer	8pF	
SEMICONDUCTOR				
IC101		IC	4066PC	
IC102		IC	78M05UC	
IC103		IC	79M05UC	
Q101, 102		Field effect transistor	2SK68 (M)	
Q103		Transistor	2SA841(BL)	
Q104		Transistor	2SC784(O)	
Q105 ~ 110		Transistor	2SA841(BL)	
Q111		Transistor	2SC784 (O)	
Q112, 113		Transistor	2SA841(BL)	
Q114, 115		Transistor	2SC784(O)	
Q116,117		Transistor	2SA841(BL)	
Q118		Transistor	2SC784(O)	
Q119, 120		Transistor	2SA841(BL)	
Q121		Field effect transistor	2SK30(Y)	
Q122, 123		Transistor	2SC784(O)	
D101 ~ 103		Diode	1S1588	
106 ~ 133		Diode	W-02	
D134		Diode	W-02	

CIRCUIT NO.	PARTS NO.	DESCRIPTION	REMARKS
CON101, 102	E40-1611-05	MISCELLANEOUS Pin connector	
	F10-1518-04	Shield plate	
	F11-0915-04	Shield case	
	S51-1503-05	Relay	

12.P.C. BOARD (X65-1210-04)

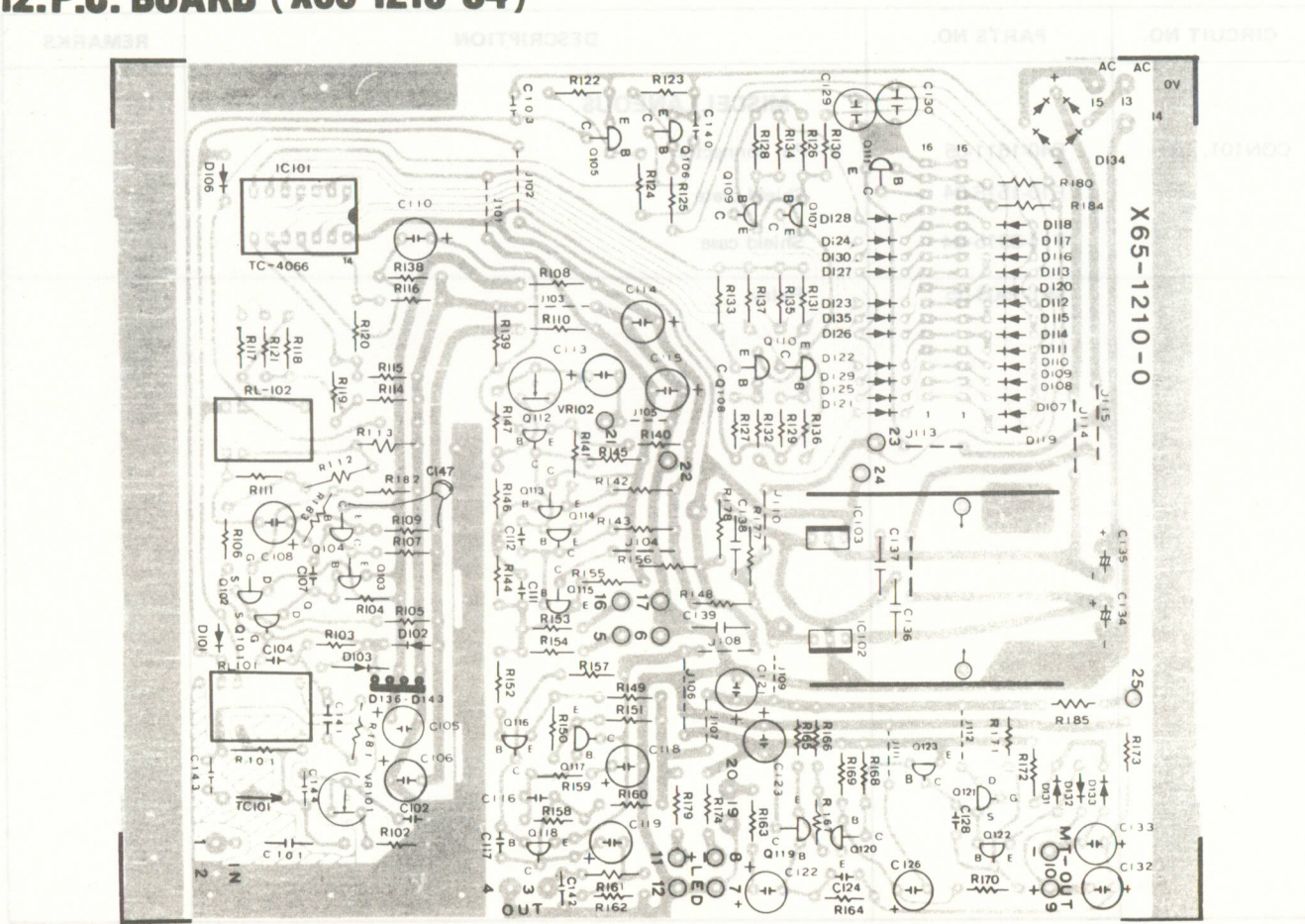

13. SCHEMATIC DIAGRAM

The circuit elements may be changed without notice owing to a technical innovation.

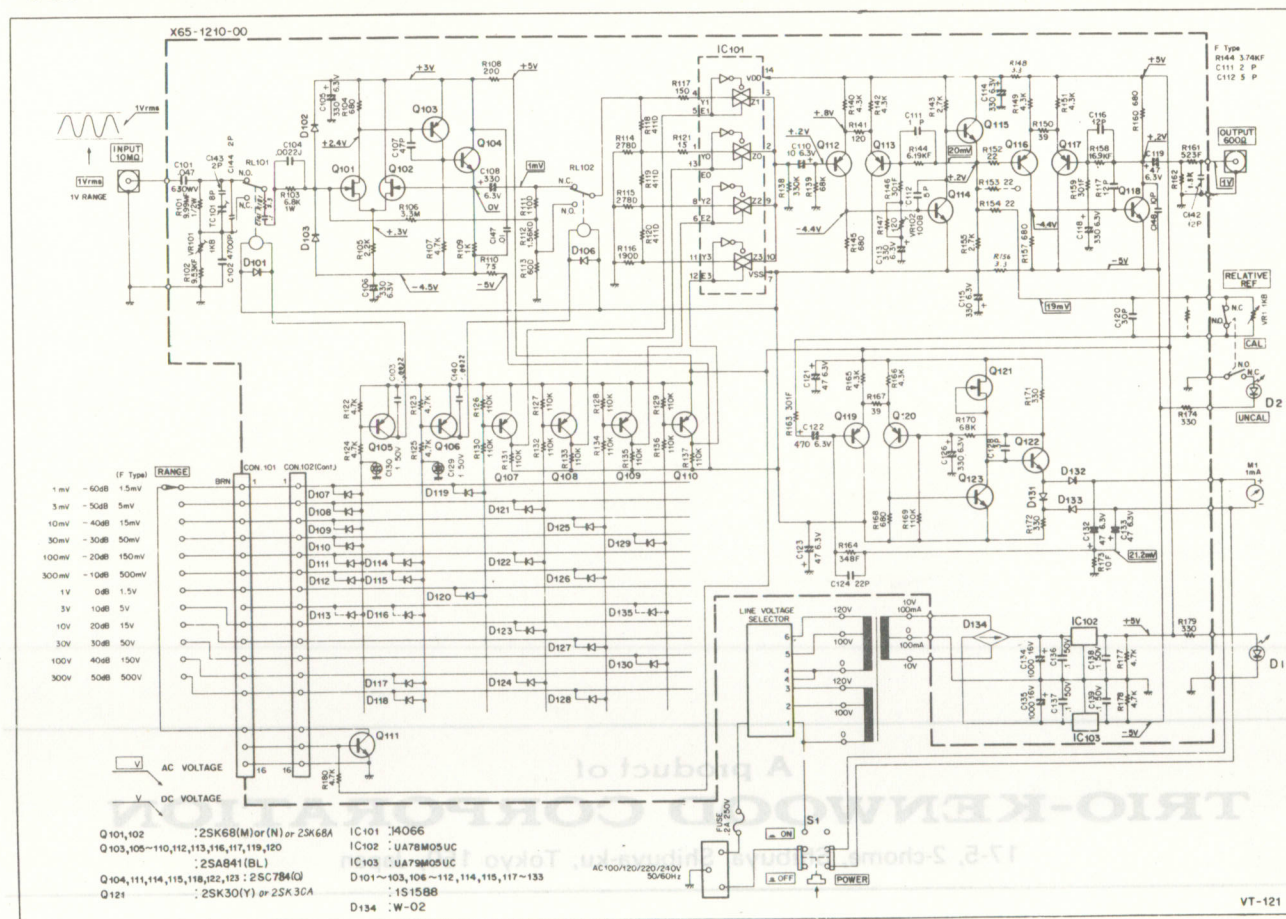

13. SCHEMATIC DIAGRAM

The circuit elements may be changed without notice owing to a technical innovation.

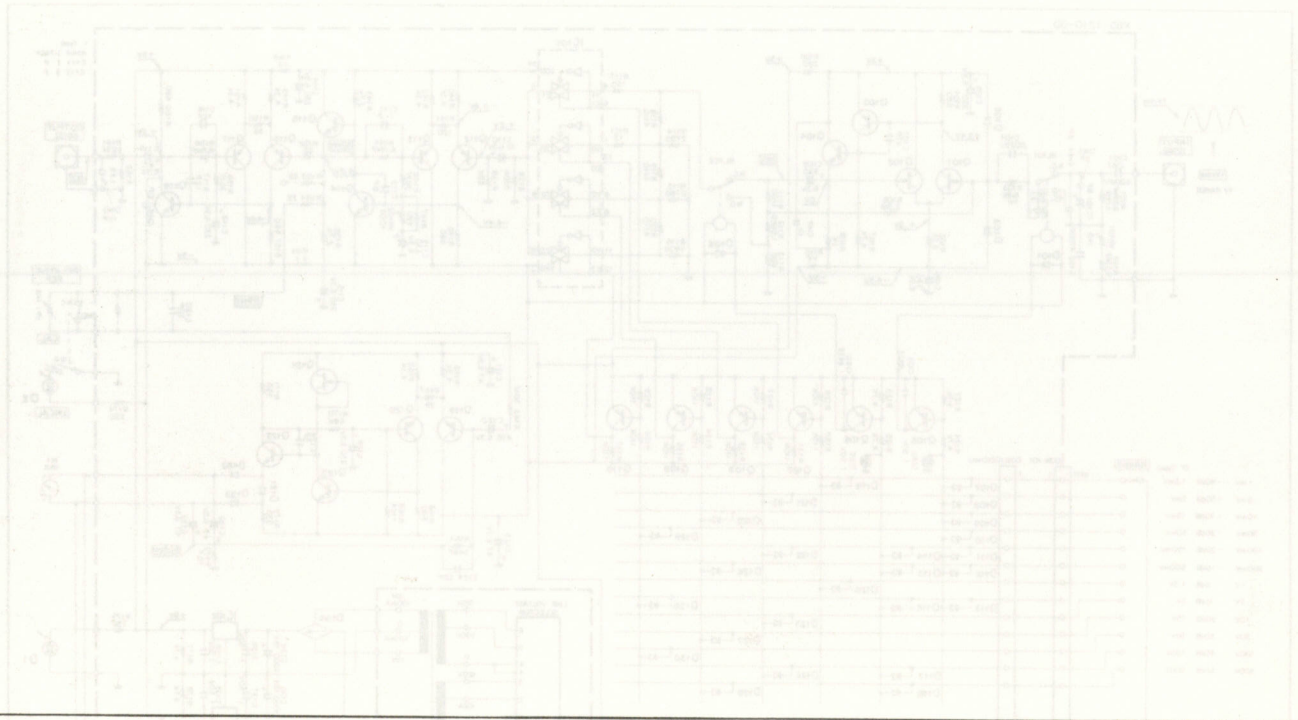

A product of
TRIO-KENWOOD CORPORATION

17-5, 2-chome, Shibuya, Shibuya-ku, Tokyo 150, Japan

© 45511 PRINTED IN JAPAN B50-2842-10 (K.O)